



Elevator Automatic rescue device A-33455E14-JN User Manual

In order to use this product safely, please be sure to read the instruction manual.
In addition, please take proper care of the instruction manual and hand it over to the end user.

Directory	I
Safety Matters & amp; specifications	II
Product Info	1
Mechanical Mounting	2
Electrical Installation	3
System debugging	4
Fault List	5
Appendix	6

I Directory

I	DIRECTORY	I
II	OBJECTIVE	1
II	SAFETY MATTERS & AMP; SPECIFICATIONS	1
1	PRODUCT INFO	3
1.1.	Confirm when the product arrives	3
1.2.	Packaging Content Confirmation	3
1.3.	Nameplate	3
1.4.	Product model	3
1.5.	Product Features	4
1.6.	Product coverage	4
1.7.	Product Features	4
1.8.	Product Specifications	4
1.9.	Temperature onARDRated Power impact	4
2	MECHANICAL MOUNTING	5
2.1.	Installation conditions	5
2.2.	Shape&Mounting dimensions	6
3	ELECTRICAL INSTALLATION	7
3.1.	Precautions	7
3.2.	Wiring Instructions	7
3.3.	Main loop Port definition	9
3.4.	Signal Line Port definition	9
4	SYSTEM DEBUGGING	10
4.1.	Man-Machine Interface description	10
4.2.	Debugging instructions	10
5	FAULT LIST	11
6	MAINTENANCE & AMP; REPAIR	12
7	APPENDIX	14
7.1.	Historical versions	14

II Objective

Please read it carefully. This use manual for installation, operation and maintenance after full understanding of its contents.

Please understand the safety precautions of the product before using the product.

◆ Important statement

The information provided in this manual is a general use and technical description of this product. For any particular application of this product, users are required to complete their own risk analysis, evaluation and testing. The company shall not be liable for any consequences arising from the misuse of the information contained in the manual.

The installation and use of this product must comply with the relevant national, regional and local regulations.

This product is used for applications with functional safety requirements and must comply with relevant safety standards and specifications.

Unauthorized modification of this series of products is strictly prohibited. The company shall not be liable for any accident caused by unauthorized modification.

The specifications of this series of products will be changed due to product improvements, without prior notice, please understand.

If you have suggestions for improvements or corrections to the relevant content in the manual, please contact us.

◆ Reader Object

User

Elevator Engineering Maintenance Personnel

User Technical support staff

◆ Reader's precautions

The diagrams in this manual are examples only and may differ from the products you order.

The contents of this manual are subject to change as a result of product improvements or changes in specifications, as well as in order to improve the convenience of the manual.

Please contact our company when you need to order this manual due to damage or loss.

The contents of this manual are confirmed to be correct at the time of printing, but our company is committed to continuous improvement of the product, so the manufacturer reserves the right to modify the product specifications, performance and other contents of this manual without notice to the user.

This manual is please be kept by the actual users of the product.



After reading, please keep this manual at any time available to the user.

It is important to ensure that this manual is delivered to the end user.

II Safety Matters & amp; specifications



Be sure to read carefully before use "Safety precautions" To ensure proper use!

The considerations listed here record important security-related content, so be sure to follow them. The level of security considerations is divided into "hazard" and "attention".



	Dangerous	If used improperly, there will be a danger that may result in death or serious injury.
	Attention	If used improperly, there will be a danger, which may lead to a moderate level of injury, or only material damage.

However, even if it is marked as "Attention" matters and, in some cases, can also have serious consequences. Therefore, no matter what level of attention is recorded in the important content, must be strictly adhered to.



The following is a description of the "Disable" and "indicate" icons.

	Ban	Represents a general prohibited matter.
	Instructions	To indicate the behavior of the general user.



◆ Installation Considerations

 Dangerous	
<ul style="list-style-type: none"> • Please strictly Comply with mechanical and electrical installation specifications for installation. • The installation must be performed by a professional who has the necessary training and has the necessary experience. • You should read it carefully before you operate This security Information and user manuals. 	
 Attention	
<ul style="list-style-type: none"> • Please install on non-combustible objects such as metal; keep away from flammable, explosive and other items. Otherwise there is a danger of fire and explosion! • Do not install in cases where liquids such as water or raindrops can splash. Otherwise, there's damage. Equipment The Danger! • Please install on an object with sufficient load-bearing capacity. Otherwise there is Equipment The danger of falling and damaging! • Do not fall into the metal and other conductive objects Equipment Internal. Otherwise there is a danger of fire and damage! • Damaged or missing components Equipment, Do not install. 	



◆ Wiring Precautions

 Dangerous	
<ul style="list-style-type: none"> • Before wiring, make sure the input power supply is disconnected. Otherwise there is an electric shock and the danger of causing a fire! • Ask a professional electrical engineer to carry out the wiring operation. Otherwise there is an electric shock and the danger of causing a fire! • Do not contact the output terminal conductor directly by hand, or let the output line come into contact with the chassis. Do not short-circuit the output line. Otherwise, it will cause electric shock and short circuit, or the danger of causing a fire! • Do not touch the circuit board directly, or it may damage the device. 	
 Attention	
<ul style="list-style-type: none"> • Please confirm whether the specification and voltage of the power supply are consistent with the rated voltage of the equipment. Otherwise there is a risk of electric shock, damage to equipment and fire! • Fasten the terminal screws according to the specified torque. Otherwise there is a danger of triggering a fire! 	

◆ Running considerations

 Dangerous
<ul style="list-style-type: none">• Do not touch when the power is connected Equipment wiring terminals and their lead lines. Otherwise there is Causing damage and The danger of electric shock!• When the elevator is overhauled Please make sure that Disconnect ARD Power switch, To prevent unwitting In case the power supply is activated. Dangerous!
 Attention
<ul style="list-style-type: none">• This device The commissioning operation must be completed after all the elevator installation and commissioning and the elevator can be put into operation normally.• Equipment Factory Has been properly set up, do not change it at will.

◆ Maintenance & inspection considerations

 Dangerous
<ul style="list-style-type: none">• Do not connect on the power supply In the state of the Inspection and Wiring operations. Otherwise there will be a risk of electric shock!• Please specify trained and authorized professionals to maintain, inspect or replace parts. Otherwise there is a danger of electric shock and damage to the controller!• Before the maintenance personnel work, please remove the metal ornaments (such as watches, rings, etc.), the operation must be used to meet the insulation requirements of clothing and insulation treatment tools. Otherwise there is a risk of electric shock!• Do not replace wiring and disassembly terminals and connectors in power-on. Otherwise there is a risk of electric shock!
 Attention
<ul style="list-style-type: none">• Control the circuit board, the use of integrated circuits, please be careful to operate.• If in direct contact with the hand, it will cause damage to the circuit board due to static electricity.

1 Product Info

1.1. Confirm when the product arrives

- Please check the appearance to confirm that the product has no scratches or dirt. Damage caused by product handling does not fall within the scope of the company's warranty. Please contact the shipping company immediately in the event of damage to the product.
- Verify that the model of the product is consistent with the order.
- If you find that the product is defective, please contact the office where the product was purchased or the sales headquarters of the company immediately.

1.2. Packaging Content Confirmation

Packaging items	A-33455E14-JN	Supporting power cord	Accessory control Line	Manual
Number	1	1	1	1

1.3. Nameplate

		自动救援装置 Automatic Rescue Device	
型号/Type:	ARD	规格/Specification:	
额定输入电压/Rated input voltage:	310~420Vac, 3phase, 50Hz		
额定输出电压/Rated output voltage:	380Vac ± 15%, 3phase, 50Hz		
额定输出功率/ Rated output power:		最大输出功率/ Maximum output power:	
蓄电池规格/ Battery Specification:		蓄电池组电压/ Battery pack voltage:	
产品编号/Mfr.No:		制造日期/Made date:	
制造商名称/Name of manufacturer:	厦门荔通科技有限公司		
制造商地址/Address of manufacturer:	福建省厦门市翔安区马巷市头工业区舫山东二路829号		

1.4. Product model

Product Seriation

A = ARD

The Input Power

3 = 3 phase input

2 = 2 phase input

Emergency Output

3 = 3 phase input

2 = 2 phase input

Output voltage

4 = 400V 2 = 220V

Adaptor power

11 = 11KW 15 = 15KW ...

Three style version number

Branch code

J = Simple type T = Universal type

KY = Customer special requirement with two capital letters

A-32415C10-KY

1.5. Product Features

- Suffix-JN The model comes with 220V Output
- The use of frequency isolation transformers, rich protection features, high system reliability
- Automatically disconnect the battery power-consumption loop to effectively extend the lifetime of the outage

1.6. Product coverage

- Control system supports single-phase power supply emergency flat layerFunction
- The control system should support the emergency level when running in the direction of labor-saving (such as no-load corresponding uplink)

1.7. Product Features

- **Standard Features**
 - ◆ The battery is charged automatically when the power supply is normal
 - ◆ After the abnormal power supply is detected, the output is only allowed when the inverter switch on the door panel is closed and the 5-pin and 6-pin short connectors on the connector are connected
 - ◆ After abnormal mains power is detected and the above conditions are met, start ac400/230v output and emergency operation signal output in 5 seconds, and the default duration is 3 minutes
- **Optional features**

1.8. Product Specifications

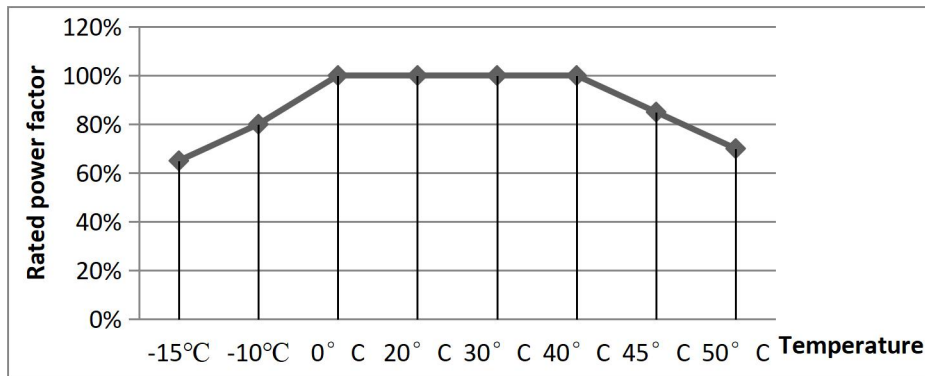

Model		A-33455E14-JN
Capacity(VA)		3900
Mains input	Voltage	3 phase AC400V±10%
	Frequency	50/60Hz
Inverter output	Voltage	3 phase AC400V±10%
	Waveform	Sine wave
	Frequency	50Hz
	Efficiency	≥0.8
	Waveform distortion	Linear rated load≤5%
Battery	Type	Plumbic acid charging-free and maintenance-free special battery
	Rescue time	2-15Min (adjustable)
	Charging time	<=6 hours
	Specification and quantity	12V/17AH×6
Environment	Temperature	0 °C ~ 40 °C
	Humidity	30% ~ 90% (non-condensable)
	Noise	≤50dB
Dimension L*W*H (mm)		420*210*500
Weight (KG) with battery		53.8

1.9. Temperature on ARD Rated Power impact



2 Mechanical Mounting

2.1. Installation conditions

 Attention	
In order to give full play to the performance of the product, long-term maintenance of its functions, installation environment is very important. Install the machine in the environment shown in the following table.	
 Instructions	
Installation Locations	Indoor
Ambient temperature	-10°C ~ +40°C <ul style="list-style-type: none"> ● In order to improve the reliability of the machine, please use in places where the temperature does not change dramatically. ● Special ambient temperature, down the amount of use.
Temperature	95RH%Following(No condensation.)
Environment	Please set theEquipmentInstalled in the following locations: <ul style="list-style-type: none"> ● Oil-free fog, corrosive gases, flammable gases, dust and other places ● Metal powders, oils, water and other foreign bodies do not enter the site inside the inverter (Do not install the inverter on flammable objects such as wood) ● A place free of radioactive substances or flammable objects ● Places free of harmful gases and liquids ● Less salt erosionThe place ● A place without direct sunlight
Altitude	1000mFollowing
Vibration and shock resistance	Less than5.8m/s ² (0.6g)
Mounting direction	Be sure to install vertically.
 Ban	
<ul style="list-style-type: none"> ● When it is necessary to prevent foreign objects from entering during the operation, when installing the operation, pleaseClose the cupboard DoorTo prevent metal chips, oil, water, etc., from entering the holeEquipmentInternal. ● Please avoid places with oil mist and dust suspension and install the machine in a clean place or in a fully enclosed control cabinet that cannot be accessed by suspended objects. When installing in the cabinet, select the cooling method and the size of the control cabinet to ensure that the ambient temperature of the machine is within the allowable temperature range. Also, do not install the machine on flammable objects such as wood. 	

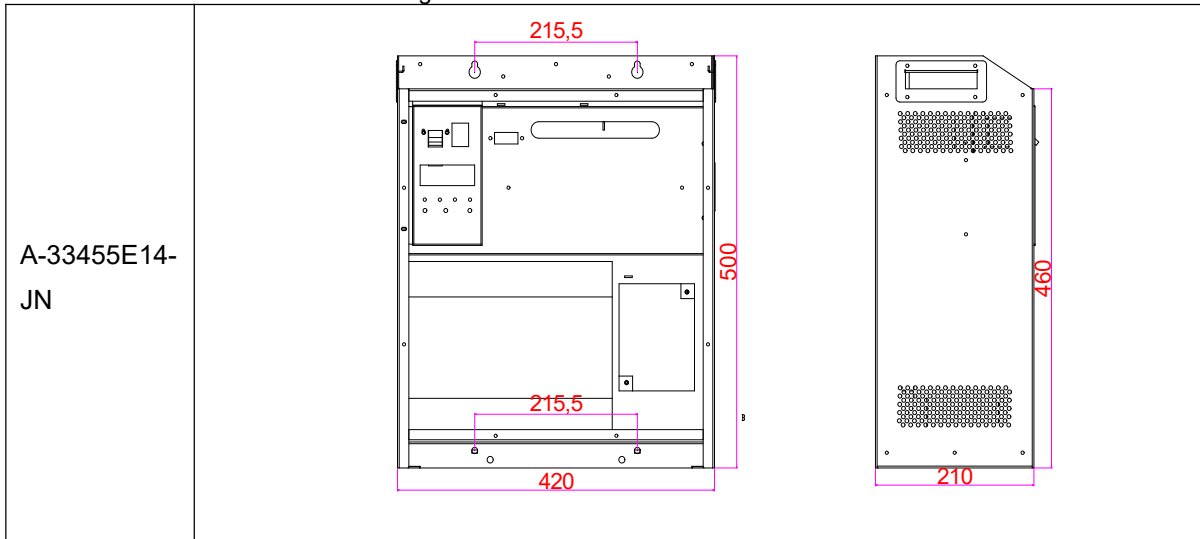

2.2. Shape&Mounting dimensions

The cabinet body of this device can be used M8 bolts are securely mounted on the structural body. The Figure size Unit is Mm. Products Contains the battery, can not be inverted for a long time, side, please install in the direction of the diagram.



3 Electrical Installation

3.1. Precautions

 Dangerous
To prevent electric shock,
Do not perform wiring operations in a power-on state. Before you carry out the inspection, please cut off Power supply of the device and other Power to all devices. Otherwise there will be a risk of electric shock.
 Attention
<ul style="list-style-type: none"> ● This device The commissioning operation must be completed after all the elevator installation and commissioning and the elevator can be put into operation normally. ● For Equipment Maintenance inspection, parts replacement and other operations before, please remove the watch, ring and other metal items. Please try not to wear loose clothes and protect your eyes with goggles and so on. Otherwise there will be a risk of electric shock or injury. ● Installation, wiring, repair, inspection and replacement of parts please be familiar with Equipment The installation, adjustment and repair of electrical construction professionals. Otherwise there will be a risk of electric shock. ● Please make sure that The protection of grounding conductors meets the requirements of technical standards and local safety standards. ● Be sure to ground the grounding terminal. (200V Level: The grounding resistance is below 100Ω, 400V Level: Grounding resistance below 10Ω). If not properly grounded, it may result in death or serious injury due to exposure to ungrounded electrical equipment. ● Do not touch the printed circuit board in a power-on state And equipment Wiring Terminals. Otherwise there will be a risk of electric shock.

3.2. Wiring instructions

■ Input power supply R、S、T、Nl

- Input side wiring, no phase sequence requirements
- External power wiring specifications and installation methods should comply with local regulations and relevant IEC standards.

■ Output Power U、V、W、NO

- Output side wiring, no phase sequence requirements
- External power wiring specifications and installation methods need to comply with local regulations and relevant IEC standard requirements.

■ Grounding Terminals (PE)

- The terminal must be reliably grounded and the grounding line resistance value must be less than 10 Omega. Failure to do so can cause the device to work abnormally or even damage.
- Do not place the grounding terminal  And the power supply 0-wire N terminal is shared.
- The impedance of the protection grounding conductor must meet the requirements of being able to withstand the large short-circuit current that may occur in the event of a failure.
- The size of the protected grounding conductor is selected according to the table below.

Grounding section Area

Cross-sectional area of a phase line (S)	Minimum cross-sectional area of protective conductors (Sp)
$S \leq 16\text{mm}^2$	S
$16\text{mm}^2 < S \leq 35\text{mm}^2$	16mm^2
$S > 35\text{mm}^2$	$S/2$

- A yellow-green cable must be used to protect the grounding conductor.

■ Control circuit terminal wiring instructions

- The motor cable should be laid away from all control cables.
- Recommended motor cables, input power cords, and control loop cables are not in the unified wiring slot. Avoid the electromagnetic interference caused by the coupling of motor cables and control loops over long distances and walking lines.

- When the control loop and the drive line must cross, the intersection angle should be 90 degrees.

■ **GroundingNote**

- EquipmentThe grounding terminal must be grounded.
- Do not share the grounding wire with the power equipment, etc.
- The ground line must not be less than 4mm² PowerEquipmentit is advisable to bold again.
- Grounding wire Please use the specifications specified in the technical benchmark of electrical equipment to shorten the wiring as much as possible.

■ **Wiring inspection**

<input checked="" type="checkbox"/>	NO.	Content
<input type="checkbox"/>		Is the model consistent with the ordered product?
<input type="checkbox"/>		Is the installation site and installation method correct?
<input type="checkbox"/>		Is the supply voltage within the range of the input voltage specification?
<input type="checkbox"/>		Is the rating correct?
<input type="checkbox"/>		Inputs the power wiring properly connected to theEquipmentInput terminals (R/L1 , S/L2 , T/L3On
<input type="checkbox"/>		Control cabinetsIs the wiring connected to theEquipmentOutput terminals (U/T1 , V/T2 , W/T3On
<input type="checkbox"/>		Is the main circuit wire size appropriate?
<input type="checkbox"/>		Is the grounding wire set to the correct method?
<input type="checkbox"/>		EquipmentIs the main circuit terminal and the screw of the grounding terminal fastened securely?
<input type="checkbox"/>		Is there a wrong wiring?
<input type="checkbox"/>		Is the screws that control the circuit terminals fastened and secure?
<input type="checkbox"/>		Are there residual wired chips, screws, etc.?
<input type="checkbox"/>		Line of the terminal partWhether it shouldContact with adjacent terminals?

■ **Power Check**

- The voltage of each phase of the user's power supply shall be within the range permitted by the rated voltage;

 Attention
● The system inlet voltage exceeds the allowable value will cause damaging consequences, to focus on inspection.

3.3. Main loop Port definition

Terminal marking	Feature description
R, S, T、 NI	Three-phase power input Terminals
U, V, WNO	Three-phase AC output terminals
PE or \oplus	Grounding Terminals

Signal CablePort definition

9 Core AnpuTerminal PIN number	Type	Feature description	12Core AnpuTerminal PIN number
1	Output	Emergency Operation signal Output	2
2			4
3	Output	Short phase sequence output	1
4			3
5	Input	Inverter control, the output is only allowed when the inverter switch ON the door plate is ON	
6			
7	Input	Inverter timing stops when the short connection is restarted	11
8			12
9			

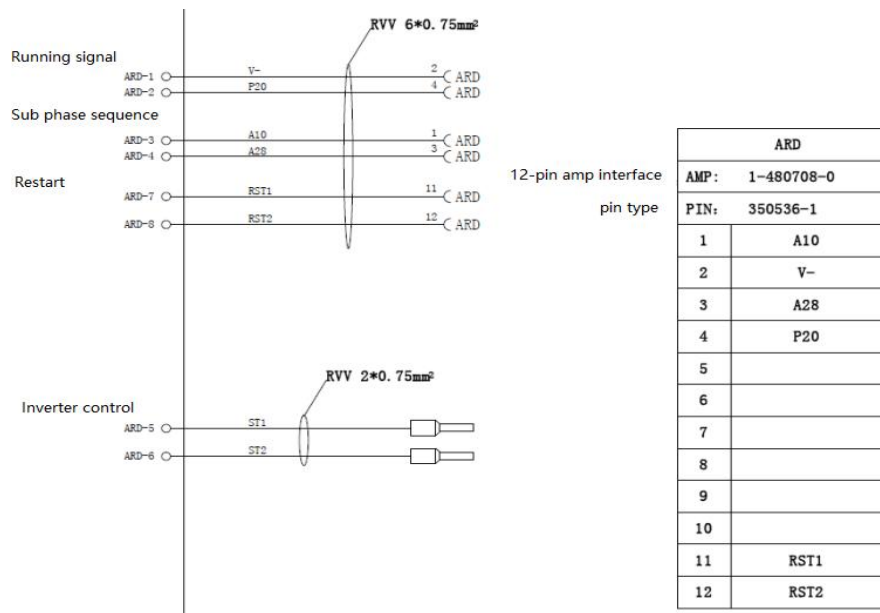

4 System debugging

4.1. Man-Machine Interface description

■ Panel switch Description

Power switch	ARD Power switch, when working properly should be set to ON. For OFF, it will no longer perform emergency rescue functions, and you can't charge the battery. Long-term non-use, please set this switch to OFF.
Inverter switches	Inverter switch, set to ON when the inverter output is allowed, it is placed OFF when inverter output is prohibited.

■ Panel LED Indicator Light Description

The device panel comes with a two-color LED. LEDs are used to indicate device status and fault information.

- If there is a malfunction, The LED flashes red, details refer to the Fault list section
- If there is no fault
 - Red light is always on: inverter output
 - Green light Flash: Charging
 - Green light is always lit: charging is complete
- Other Scenarios LED Off

4.2. Debugging instructions

- The connection between ARD and the elevator control cabinet must be completed in the elevator installation and commissioning, and the elevator can be put into operation normally.
- First disconnect the total power supply of the elevator control cabinet, do not operate on electricity, and then follow the connection instructions to connect ARD with the elevator system connection; Please make sure that the input line and the output line are not connected incorrectly
- First access to the normal power, and then the ARD panel on the switch to on, ARD in standby mode, battery group for automatic charging.
- Electricity interrupt and plug in inverter control on the terminal is connected and the emergency rescue function is performed after the set time (the default setting of 5S)

5 Fault List

If the LED indicator light on the device panel is flashing red, it means there is a fault. The judgment shall be made according to the number of flashes in the table below:

LED flashes red number of times	Fault description	Analysis and Countermeasures	LED flashes red number of times	Fault description	Analysis and Countermeasures
1	Overcurrent or overload	<ul style="list-style-type: none"> If the load is too large, the output short circuit or the circuit board is damaged, please check whether the load and ARD are suitable and the output is short-circuited 	4	Main CONTACTOR Not disconnected	<ul style="list-style-type: none"> Check the cabinet to see if the main contactor is glued or damaged. Check that the circuit board J1 Terminal and its corresponding cable are reliably connected
2	Battery Undervoltage	<ul style="list-style-type: none"> Recharge after battery discharge (e.g. long-term idle, etc.) should replace the battery pack For normal discharge after the situation, please charge in time 	5	Main CONTACTOR not sucked	<ul style="list-style-type: none"> Check that the circuit board J9 Terminal and its corresponding cable are reliably connected Check that the circuit board J1 Terminal and its corresponding cable are reliably connected May be damaged for contactor
3	Battery overpressure	<ul style="list-style-type: none"> Please check that the battery is configured according to the battery specified in the specification table on the manual 	6	Output voltage Error	<ul style="list-style-type: none"> Please check if the input and output of the power cord is connected to the reverse

6 Maintenance & repair

In order to ensure the product can work normally, it must be checked and maintained regularly in daily use. If there is any abnormality in the process of using the product, please stop using it to find the reason and solve it immediately.

Transport, storage

■ Transportation precautions

Avoid falling during controller handling to prevent violent vibrations or mechanical impacts. If this occurs, the controller will become corrupted or function abnormally.

■ Storage conditions

Avoid using or storing controllers in any of the following environments:

1. Exposed to direct sunlight.
2. Exceeding the temperature and humidity environment defined by the controller specifications.
3. It is easy to appear in the environment where the temperature changes dramatically and produces condensation.
4. The environment of corrosive or flammable gases.
5. Dust, salt mist, oil, water vapor or the presence of chemical substances in the environment.
6. An environment of shock or vibration.

Adequate protective measures must be taken in the following environments, and there is a risk that the measures are not in place to fail:

1. An environment in which static or other forms of noise exist.
2. There is a strong electromagnetic field radiation environment.
3. An environment in which radioactive rays exist.
4. Too close to the high-power power supply, frequency converter and other power equipment environment.

■ Storage precautions

Should be placed in a dry and ventilated environment, to avoid the sun and rain, the number of stacked layers of products should not be too high.

Unpacking & inspection

Check whether the accessories are complete, the surface is damaged incorrectly, whether there is a barcode and whether there is a test PASS label.

Battery Maintenance

Battery life is shortened with an increase in ambient temperature (25 °C), with regular battery replacement (2~3 years) to ensure that ARD is working properly and has sufficient battery discharge time.

- Use to recharge after initial use or long-term placement.
- At the ambient temperature of the <0°C, the internal chemicals of the battery are affected by temperature and the discharge time decreases dramatically.
- The battery has self-discharge phenomenon, in the short term without conditions, about three months need to charge the battery once to ensure that the battery will not be damaged.
- Battery maintenance and replacement of batteries can only be carried out by professional and technical personnel.
- There is a risk of electric shock and short circuit current for replacing the battery. To avoid electrocution accidents, follow these warnings when replacing batteries:
 - Do not wear watches, rings or other metal items;
 - Use insulated tools and wear insulated gloves;
 - Do not place metal items on the battery;
 - It is strictly forbidden to short-circuit the battery positive and negative, which can cause electric shock or fire.
- The steps to replace the battery are as follows:
 - Disconnect all power loops and external input power from the device
 - Unload/Fixing plate/Then remove the old battery group cable
 - Replacement of battery groups (in principle, can only be replaced throughout the group)
 - Connect the new battery group in its original way and install it on the fixing plate

**Attention**

Lead acid battery can not be inverted for a long time, side

- Battery Life Forecast: 2~3 Year
- The impact of low battery power: Insufficient discharge time and power reduction of equipment
- Battery Storage considerations:

**Instructions**

The following basic principles should be observed when storing batteries:

- Store the battery in a cool, dry place
- Recommended storage temperature °C (77°F), relative humidity 40%~60%.

Other

- Production Plant Guarantee

The warranty period of the product shall be within one year of delivery to your company or your customers, or within 18 months from the date of shipment, whichever is the first time.

- After-Sales service matters

Fault diagnosis

The initial fault diagnosis, in principle, is implemented by your company.

However, at the request of your company, the company or the company's service network can provide fee-paying services.

At this time, according to the outcome of the negotiations with your company, if the cause of the failure is on the company side The service Free.

Fault Repair

In view of the failure, need to carry out repair and product exchange, the company can send personnel free door-to-house service. However, the following occasions are chargeable services.

- Malfunction caused by incorrect custody and use, negligence or application design of your company and your customers, etc.
- In the event that the company does not know, your company Private to The modification of the company's products caused a malfunction.
- In the company's product specifications outside the scope of the use, caused by the failure.
- Causes faults such as natural disasters and fires.
- Other reasons that are not the responsibility of the company cause malfunction.

Beyond the assurance of liability

Due to the failure of the company's products, to your company or your company's customers inconvenience and resulting in the breakage of non-the company's products, whether or not within the warranty period, do not belong to the scope of the company's guarantee.

- Contact information

Address: Wuxi City, Jiangsu Province Binhu district Building 18th, science and Education Software Park, No. 100th Kam Xi Road

Zip Code: 214125

Tel: (+86) 510-68869600 (+86) 510-68869722

Fax: (+86) 510-85166186

Url: [Http://www.nidec-ket.com](http://www.nidec-ket.com)

7.1. Historical versions

◆ Revision History:

Released Date	Revision	Chapter	Changes
2019/4/15	1.0	-	New

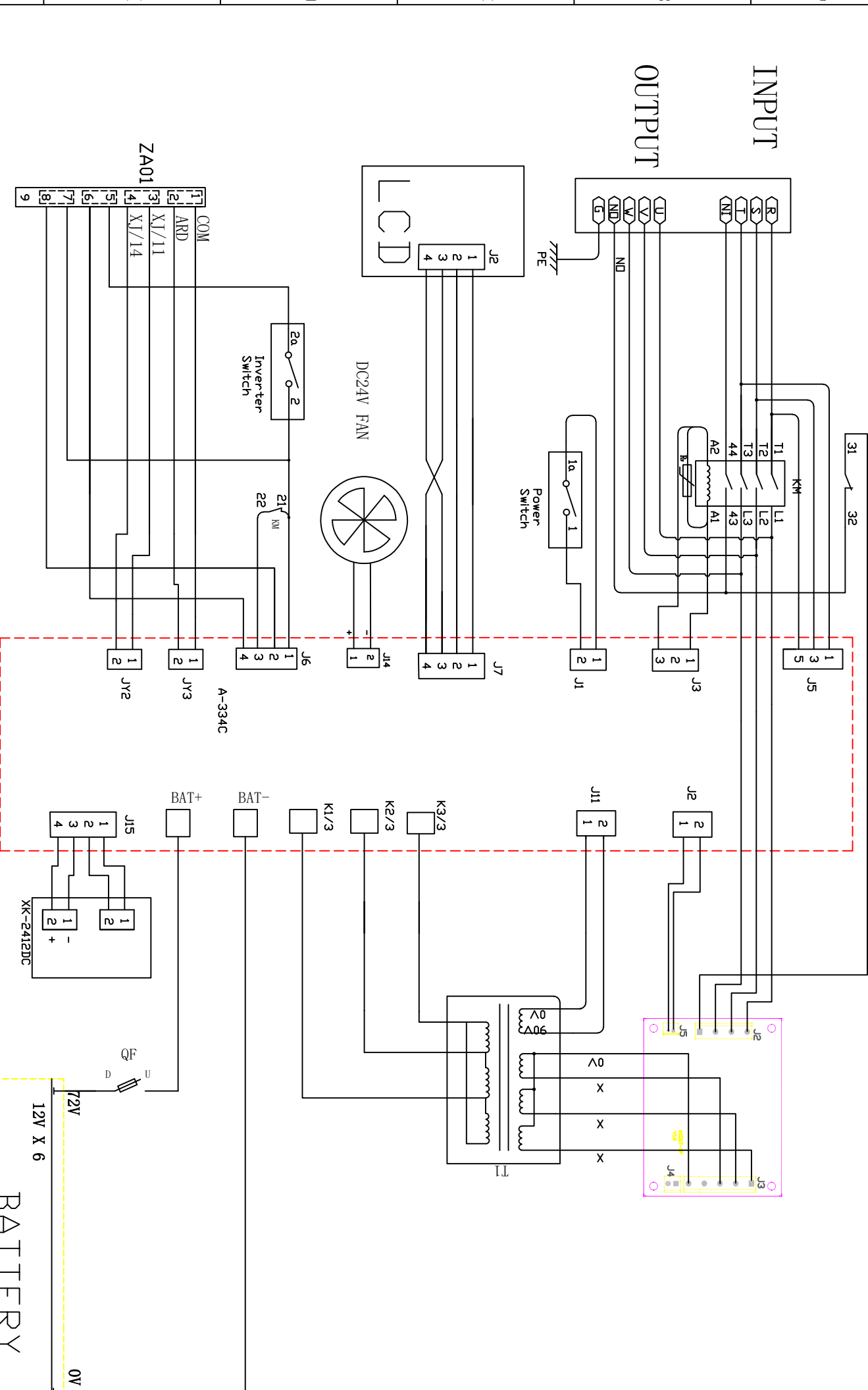

Designed by Minzhilu	Reviewed by	Issued by	Xiamen Xietong Technology Co.,Ltd		Internal Wiring Diagram	Model NO. A-33X40/55E14-JNDK
1	2	3	4	5	6	Revision V11
1	2	3	4	5	6	Date
1	2	3	4	5	6	7
1	2	3	4	5	6	8

With AC220V Output

12V X 6

BATTERY

Power supply box

XT-3ARD-334XXC-JN

Elevator control cabinet

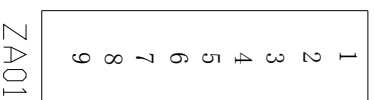
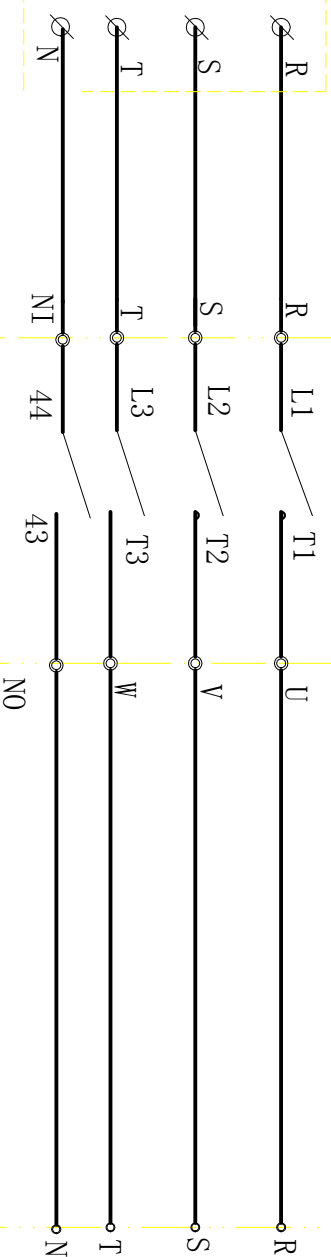

(6*0.75)*3M

(2*0.75)*3M

Num Note

Identifier

Num Note	Identifier
1 COM	ARD-1
2 Control system for ARD signal	ARD-2
3 Phase sequence relay/11	ARD-3
4 Phase sequence relay/14	ARD-4
5 Main power switch detection	ARD-5
6 Main power switch detection	ARD-6
7 Start switch 1	ARD-7
8 Start switch 2	ARD-8
9 Spare	

1	2	3	4	5	6	7	8		
Designed by	ZhiHuang	Standard			Xiamen XieTong technology Co.,Ltd			Model NO	XT-3ARD-334XXC-JN
Checked by	LIZhenFan	Auditing						Revision	20170901-V1.0
1	2	3	4	5	6	7	8		